

# D-LED Lighting

## DIN-Rail Smart Power LED Controller

Model DR-SD6/12 (firmware version 1.6)

User Manual

Rev. Date: September 20, 2010



Made in Israel

### Contact information

D-LED Technologies LTD

9 Hangar St. P.O.Box 7180

Israel, 45421

Tel: +972 9 7444222

Fax: +972 9 7466466

info@d-led.net

<http://www.d-led.net>



**dled**  
Illumination technologies

## Contents

Chapter 1: Introduction.....	2
1.1 Features.....	2
1.2 Applications .....	2
1.3 Safety Warnings.....	2
Chapter 2: Mounting and Installation .....	3
2.1 Unit Connection.....	4
Physical View .....	4
Power Wiring .....	4
PSU selection guidelines .....	4
LED Output Wiring.....	5
DMX512 Data wiring .....	6
Chapter 3: Unit Setup and Operation .....	7
3.1 Unit Power-Up sequence.....	7
Power Supply Test .....	7
LED Wirings Test .....	7
Auto Load Detection.....	8
DRTP – DR-SD Driver Thermal Protection .....	8
3.2 Menu Navigation.....	9
DMX-512 Mode.....	10
Manual Mode.....	10
Status Menu .....	10
Setup Menu .....	10
Manual Edit.....	10
DMX Setup .....	11
LCD Contrast .....	12
Number of Channels .....	12
Admin Maintenance .....	12
Updating the Firmware version.....	20
Output Status Menu.....	14
3.3 RDM Functionality.....	15
RDM Functions .....	15
3.4 TP- Fixture Thermal Protection .....	16
3.5 Technical Data .....	17
Typical Characteristics.....	18
Chapter 4: Problem Solving .....	19
4.1 Troubleshooting .....	19

## Chapter 1: Introduction

The DIN-Rail DR-SD6/12, is a multiple current source solution, caters for applications up to 360W<sup>1</sup> LED lighting. The 6/12 channel (2/4 Output<sup>2</sup>) DMX-512 controllable independent current sources, allow all the flexibility you need in driving your high brightness LEDs.

### 1.1 Features

- DMX512-A compliant with autoaddressing functionality
- RDM - Remote Device Management (Optional)
- Setup via front panel LCD interface
- Smooth LED light dimming
- Continuous current output eliminates flickering
- Very high efficiency (up to 95%)
- Auto Load Detection - Allowing connection of 1 to 12 serried LEDs per each channel
- Self diagnostics prevent damage to the unit and to the LEDs
- Wrong wiring, open/short protection for each Output with indication on LCD
- *TP* - Thermal Protection of LEDs on each Output (on supported LED luminaries)
- *DRTP* - Thermal Protection algorithm prevents driver from overheating
- Can be powered by a wide range of DC Power Supplies
- Industrial DIN Rail profile, easy mounting and installation

### 1.2 Applications

- Architectural illuminations
- LED Lighting effects
- Theatrical LED lighting
- Commercial lighting
- Home lighting

### 1.3 Safety Warnings

#### ENG

1. Unit intended for maximum operating ambient 40°C.
2. Readily accessible double-pole circuit breaker (for disconnection of "+" and "-"), suitably certified in accordance with National Code and requirements and rated max. 15A shall be provided in building installation for DC mains supply disconnection.

#### FR

1. Unité destinés ambiante maximale de 40°C.
2. Facilement accessible le double disjoncteur tripolaire (pour la déconnexion de "+" et "-"), dûment certifiés conformément au Code national des exigences maximale nominale. 15A doit être prévu dans la construction de l'installation de la déconnexion du réseau d'alimentation DC.

<sup>1</sup> 12(channels) x 12(LEDs per channel) x (2.5W per LED) = 360W

<sup>2</sup> Output refers to the 3 channels of the terminal block

## Chapter 2: Mounting and Installation

The DR-SD Driver is designed to snap onto a standard DIN Rail for installation in a wall mount enclosure. LED wiring connections are made using pluggable screw terminals, DC Power In connection using the captive screws and RJ-45 DMX512 input/output positioned along the top, clearly accessible from the front for easy installation and servicing.

When installed in an enclosure utilizing 45 mm cutouts, the DR-SD Driver's front panel LCD stays visible while the connections are concealed.

For proper installation and subsequent operation of each Unit, pay special attention to the following recommendations :

- ❖ Upon unpacking the product, inspect the contents of the carton for shipping damages. Do not install damaged Units.
- ❖ Ensure proper ventilation of each Unit and avoid areas where corroding, deteriorating or explosive vapors, fumes or gases may be present. Each Unit must be oriented with Power In terminal block and DMX Data connectors towards the top to permit proper heat dissipation.
- ❖ Allow for proper clearance of Unit enclosure and wiring terminals for easy access, hardware configuration and maintenance.
- ❖ Ensure that the Unit is securely attached, properly mounted, and free of excessive vibration.
- ❖ Avoid touching the housing's surface during the operation, power down the Unit and allow it to cool down before touching the housing.
- ❖ The Unit must be mounted on a DIN Rail profile:
  1. Make sure that the DIN Rail is properly mounted on the wall.
  2. Simply clip the Unit onto the DIN Rail.

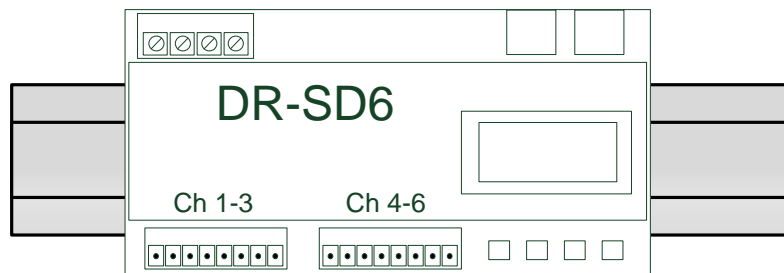

- ❖ The Unit's housing can get hot during a continuous operation with a connected load.
- ❖ Ensure that power is disconnected before installing, wiring, or servicing the Unit.
- ❖ Do not attempt to install or use the Unit until you read and understand the installation instructions and safety labels.
- ❖ Do not use the Unit if power cables are damaged.



The instructions and precautions set forth in this user guide are not necessarily all-inclusive, or relevant to all applications as D-LED cannot anticipate all conceivable or unique situations.

## 2.1 Unit Connection

### Physical View

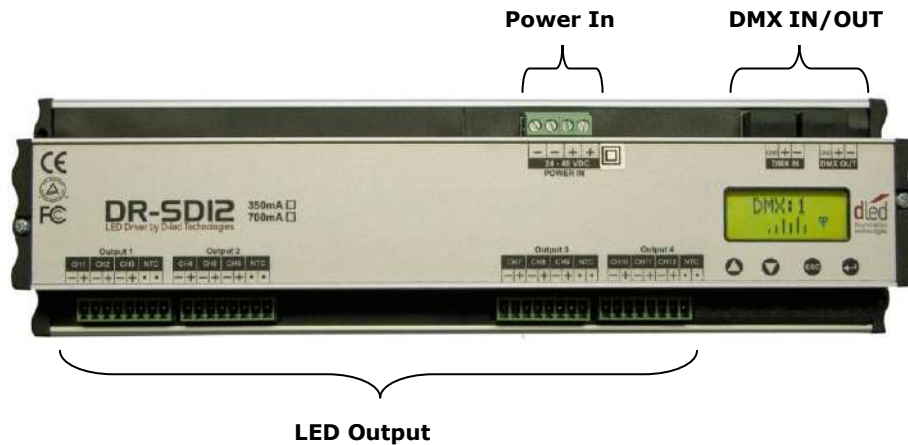

### Power Wiring

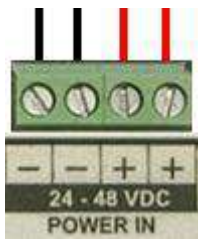

- ❖ Please follow the PSU selection guidelines below in order to select the correct Power Supply.
- ❖ Use at least 15 AWG (1.5mm<sup>2</sup>) for DC Power In connection.
- ❖ It is highly recommended to connect all 4 terminals of the Power In captive screw terminal.



Maintain correct polarity when connecting the Power Supply. Failure to do so may cause damage to the Unit.

### PSU selection guidelines

The PSU must be selected while considering the maximal number of serried LEDs per channel in the application, output cable type/length and the power rating needed to drive the LEDs at the desired current.

Below is a table that illustrates the relationship between the variables.

Number of LEDs in Series	Total V <sub>f</sub> of LEDs (typ.)	Recommended PSU Voltage	Minimal PSU Power Rating for DR-SD6		Minimal PSU Power Rating for DR-SD12	
			@350mA	@700mA	@350mA	@700mA
1	3.5V	24V	10W	20W	20W	40W
2	7V	24V	18.8W	37.6W	37.6W	75.2W
3	10.5V	24V	26.5W	53W	53W	106W
6	21V	24V	50.3W	100.6W	100.6W	201.2W
9	31.5V	36V	72.8W	145.6W	145.6W	291.2W
12	42V	48V	92.6W	185.2W	185.2W	370.4W

**Cable type / length limitations for different LED loads:**

At driving current 350mA

AWG COPPER	Diameter mm	Ohms per km	Max amps for power transmission	Voltage Drop (100m,350mA)	max. LEDs 50m	max. LEDs 100m	max. LEDs 150m	max. LEDs 200m	max. LEDs 250m	max. LEDs 300m	max. LEDs 400m	max. LEDs 500m
26	0.40386	134	0.36(2.2)	4.69	12	10	9	8	7	5	3	X
24	0.51054	85	0.57(3.5)	2.975	12	12	11	10	9	8	6	5
22(0.34mm <sup>2</sup> )	0.64516	53	0.92(7)	1.855	12	12	12	11	11	10	9	8
18(0.75mm <sup>2</sup> )	1.02362	21	2.3(16)	0.735	12	12	12	12	12	12	11	11
15(1.5mm <sup>2</sup> )	1.45034	11	4.7(28)	0.385	12	12	12	12	12	12	12	12

At driving current 700mA

AWG COPPER	Diameter mm	Ohms per km	Max amps for power transmission	Voltage Drop (100m,700mA)	max. LEDs 25m	max. LEDs 50m	max. LEDs 100m	max. LEDs 150m	max. LEDs 200m	max. LEDs 300m	max. LEDs 400m	max. LEDs 500m
26	0.40386	134	0.36(2.2)	9.38	12	10	8	5	3	X	X	X
24	0.51054	85	0.57(3.5)	5.95	12	11	10	8	7	3	X	X
22(0.34mm <sup>2</sup> )	0.64516	53	0.92(7)	3.71	12	12	11	10	9	7	5	3
18(0.75mm <sup>2</sup> )	1.02362	21	2.3(16)	1.47	12	12	12	11	11	11	10	10
15(1.5mm <sup>2</sup> )	1.45034	11	4.7(28)	0.77	12	12	12	12	11	11	10	9



- ❖ All max. LEDs' values are per channel.
- ❖ Green color means that full load can be used at the specified cable type / length.
- ❖ Yellow color means that only a limited amount of load may be used at the specified cable type / length as stated in the relevant row / column.
- ❖ Red color means that the specified cable type / length cannot be used.

**LED Output Wiring**

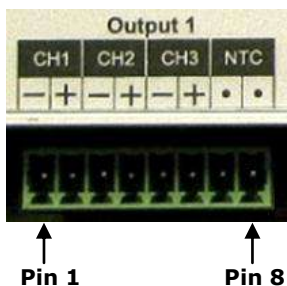

- ❖ Please refer to cable type / length limitations tables above for selecting correct cable type.
- ❖ DR-SD Driver features the **TP** - Fixture Thermal Protection which protects the LED fixture from overheating while maintaining light output. For more information about thermal protection, please see the *TP- Fixture Thermal Protection* section.



If the NTC sensor is not connected, TP protection will be disabled for that Output.

**Typical LED fixture connection:**

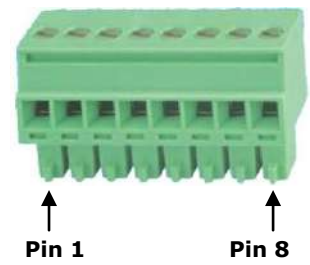
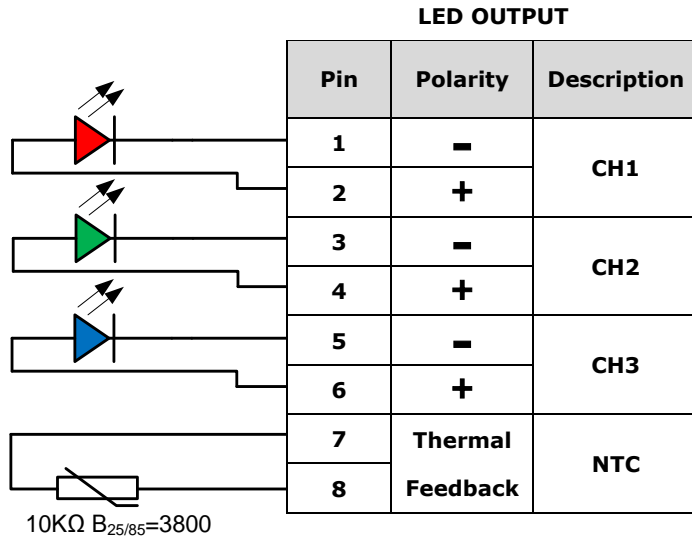

**DMX512 Data wiring**

**RJ-45 DMX IN/OUT connector pinout**

Pin	DMX IN Signal	DMX OUT Signal
1	Data -	
2	Data +	
3	GND	
4	N.C.	
5	+16VDC / 0.3A	N.C.
6	N.C.	
7		
8		

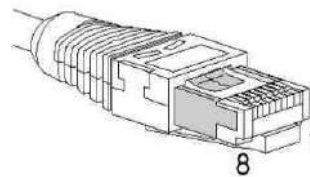

- ❖ The onboard 16 VDC can be used to supply power to a DMX controller from the DMX IN RJ-45 connector.
- ❖ This Unit has an active DMX signal levels repeater which eliminates the need of DMX splitter/repeater when daisy chaining SD-DR Units together.



- ❖ Before connecting any DMX controller, refer to the installation guide of the controller manufacturer.
- ❖ If onboard 16 VDC power output is not used, make sure that this line is isolated from any other pins.

## Chapter 3: Unit Setup and Operation

### 3.1 Unit Power-Up sequence

After applying power to the Unit, it will perform a quick self test for correct Output LED wiring and a proper voltage from the DC Power Supply. Each of these tests is followed by corresponding messages on the LCD screen.

#### Power Supply Test

After applying power to the Unit, the following message is displayed on the LCD screen:

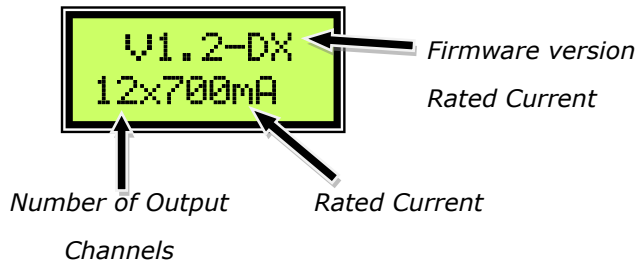

If voltage from the PSU (**P**ower **S**upply **U**nit) is not in the allowed range, the unit **will not operate** and the following message will be displayed:

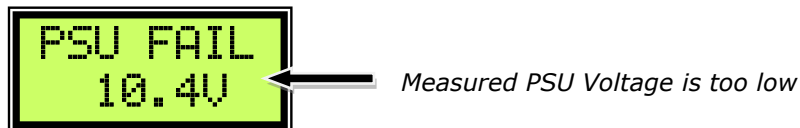

Please refer to the PSU selection guidelines section to select the correct Power Supply.

#### LED Wirings Test

This Unit has a unique, algorithm for detecting load type and wrong LED connections. It can detect if the LED's (+) and (-) lines are having a short circuit between them or mixed connection with a neighbor channel inside the terminal plug. If the Unit detects an incorrect wiring on one of the outputs, that group of channels will not be operational until the problem is fixed.

If during normal operation, some of the LEDs are reconnected, the LED Wiring Test will be initiated on the group which the disconnected channel belonged to.

That way LEDs can be hot-plugged into the system, however connecting/disconnecting LED while powered on is not recommended. It is always better to make all of the connections first and then turn the power on.



### **Auto Load Detection**

Each channel of the DR-SD is capable of auto-detecting the LED load type connected to it and selecting the appropriate operating mode to control that load.

### **DRTP – DR-SD Driver Thermal Protection**

The DR-SD has internal temperature sensor which allows it to monitor the temperature of the internal power circuitry. If by any reason external ambient temperature rises above the permitted limit, the Unit will not let the internal circuitry to overheat by reducing the output power. By doing so, it's avoiding Driver malfunction caused by overheating, still driving the LEDs even at worst conditions and preserving DR-SD Unit's lifetime.



Please refer to the Typical Characteristics page to see Output Derating Curve

### 3.2 Menu Navigation

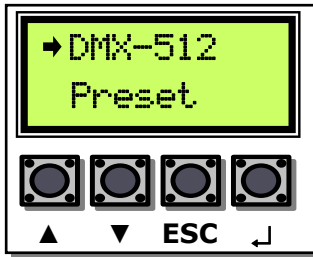

Press **[▲]** and **[▼]** to navigate through options/change setting

Press **[↵]** to enter sub menu/confirm changes

(hold to enter Output Status from DMX-512 or Manual modes)

Press **[ESC]** to go back to the upper menu/discard changes

(hold to return from DMX-512 or Manual modes)

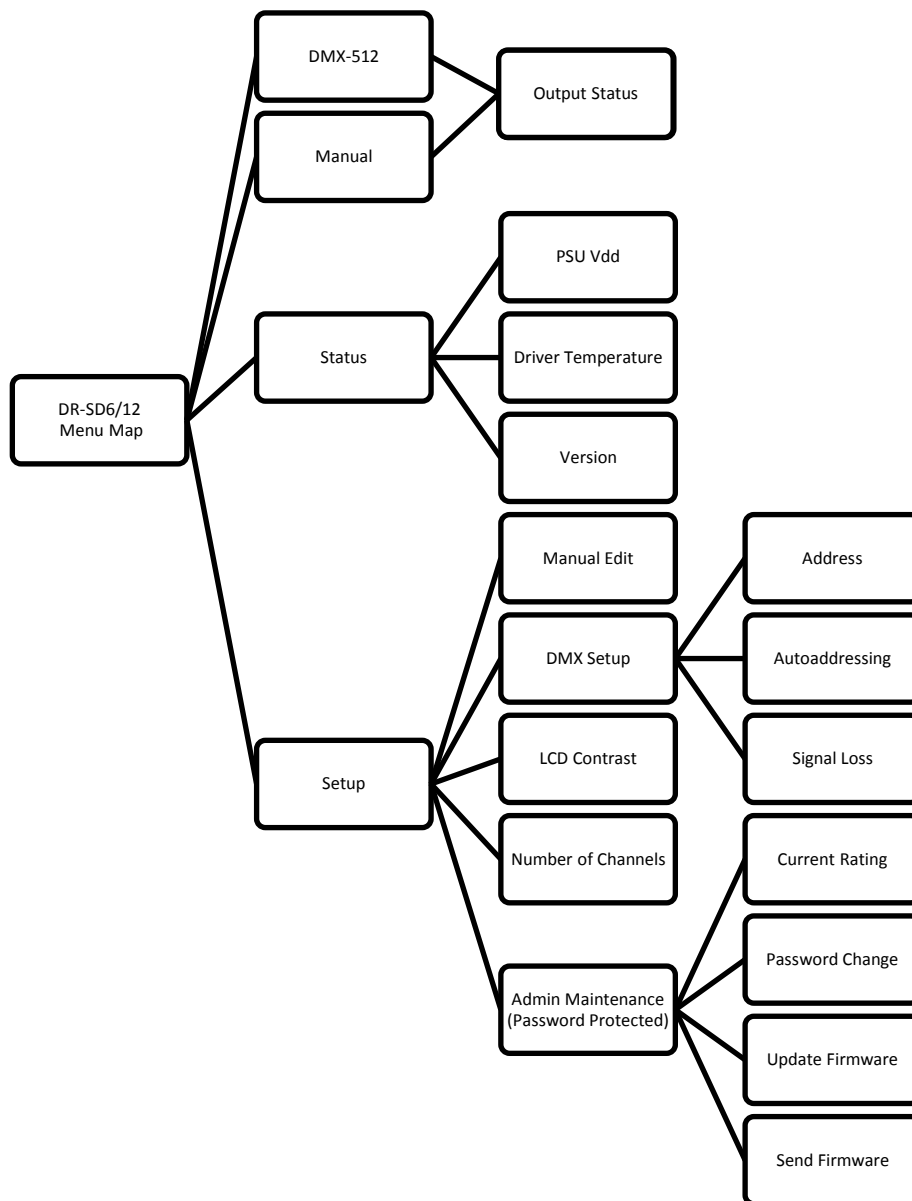

When powering unit up, it starts in the last run mode (DMX-512 or Manual)

## DMX-512 Mode

This mode is for standard DMX512 signal control

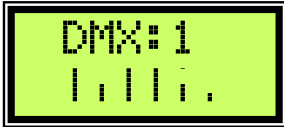

DMX:xxx

Unit's DMX-512 Start Address

ADMX:xxx – ADMX means that autoaddressing is enabled

Bottom LCD line shows graphic bar representation of DMX input Signal values

## Manual Mode

This mode is for a static scene output.



You can set the channel values for this mode inside the Setup menu.

## Status Menu

From this menu you can check system status of the DR-SD6/12 Driver.

- PSU Voltage – Power Supply Unit Voltage
- Driver Temperature – Shows the temperature<sup>3</sup> of the driver's internal PCB.
- Version – Shows firmware version and *Current Rating* of the Driver.

## Setup Menu

From this menu you can edit various settings such as DMX Start Address, LCD Contrast, Manual Mode channels edit and Current Rating.

## Manual Edit

In this menu you can edit the values of each channel of the Manual Mode.

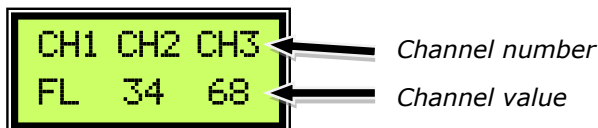

The highlighted option will flash.

Press [↵] to highlight channel number or channel value.

When channel number is highlighted press [▲] and [▼] to scroll between the channels.

When channel value is highlighted press [▲] and [▼] to change the channel value (hold [▲] or [▼] to change the value quickly).

Press [ESC] to return to previous menu, when prompted press [↵] to save changes or press [ESC] to discard changes.

<sup>3</sup> The temperature value shown is an approximate value and accurate only at temperatures >40°C

## DMX Setup

In this menu you can change the DMX address of the Unit, enable/disable the autoaddressing function and set up the behavior of the Unit in case DMX signal is lost.

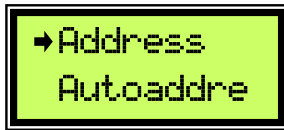

- **Address:**

Press **[▲]** and **[▼]** to change the DMX address of the Unit (hold **[▲]** or **[▼]** to change the number quickly).

Press **[↵]** to save & exit.

Press **[ESC]** to exit without saving.

- **Autoaddressing:**

Press **[▲]** to enable the autoaddressing, press **[▼]** to disable autoaddressing.

Press **[↵]** to save & exit.

Press **[ESC]** to exit without saving.

- **Signal Loss:**

- **Hold** – the Unit retains the last received values before the DMX signal was lost.
- **All 100%** - all channels' values shall be set to 100% (FL) in case the DMX signal is lost.
- **Manual** – channels' values shall be set in accordance to the values set for Manual Mode<sup>4</sup>.

Press **[▲]** and **[▼]** to scroll between the settings.

Press **[↵]** to save & exit.

Press **[ESC]** to exit without saving.

---

<sup>4</sup> Refer to Manual Edit section

## LCD Contrast

In this menu you can change the contrast level of the LCD.



Press **[▲]** and **[▼]** to change the contrast level.

Press **[↵]** to save & exit.

Press **[ESC]** to exit without saving.

## Number of Channels

In this menu you can limit the maximum number of control channels from 1 to 12<sup>5</sup>. For example if number of working channels set to 6 channel mode - channels 7-12 will be a copy of 1-6. If number of working channels set to 3 - channels 4-6, 7-9, 10-12 will be a copy of 1-3.

This function is designed to allow synchronous operation of several/all channels.

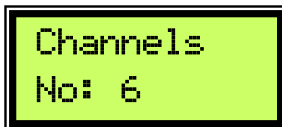

Press **[▲]** and **[▼]** to change the number of channels.

Press **[↵]** to save & exit.

Press **[ESC]** to exit without saving.

## Admin Maintenance

This menu is protected by a password in order to prevent accidental change of the Current Rating Setting. Current Rating is a maximal current in [mA] that the Unit shall output at full (FL) channel value.

The default factory preset password is: 512.

The password can be changed in the Password Change menu.

The current rating can be changed from 50 to 700 mA in the Current Rating menu.

Entering the password:

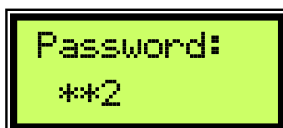

The highlighted digit will flash.

Press **[▲]** and **[▼]** to change the highlighted digit.

Press **[↵]** to highlight next digit.

Press **[ESC]** to quit.

---

<sup>5</sup> DR-SD6: 1 to 6, DR-SD12: 1 to 12

The available options are:

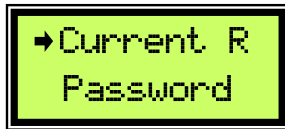

- **Current Rating:**

Press [▲] and [▼] to change the current rating of the Unit (hold [▲] or [▼] to change the value quickly).

Press [↵] to save & exit.

Press [ESC] to exit without saving.

- **Password<sup>6</sup> Change:**

Press [▲] and [▼] to change the password (hold [▲] or [▼] to change the number quickly).

Press [↵] to save & exit.

Press [ESC] to exit without saving.

- **Update Firmware:**

Press [↵] to select this option if you want to update the firmware<sup>7</sup> of your Unit.

- **Send Firmware:**

Press [↵] to select this option if you want to send the firmware from your Unit to another Unit.

---

<sup>6</sup> Password is a 3 digit number, which can be set in the range: 000~999.

<sup>7</sup> Refer to the Firmware Update section.

## Output Status Menu

The Output Status Menu can show information about the status of connected fixtures, such as: voltage, current, temperature and thermal protection dimmer value.

This menu can be accessed from DMX-512 or Manual Mode by pressing and holding [↵] .



Press [▲] and [▼] to scroll between the Outputs.

Press [↵] to view status of the selected Output.

Press [ESC] to exit the Output Status menu.

Select the desired Output and press [↵]

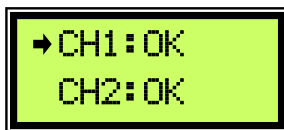

### Normal operation indications:

The normal channel statistics are:

- CHXX: OK – indicates that the LEDs connected to the channel operate normally.
- CHXX: Unplugged – indicates that no LEDs are connected to the channel.



XX indicates number of channel, can vary from 1 to 12.

Press [▲] and [▼] to scroll between the tree channels of the selected Output.

Two bottom statistics are thermal feedbacks<sup>8</sup> from the fixture connected to the output.

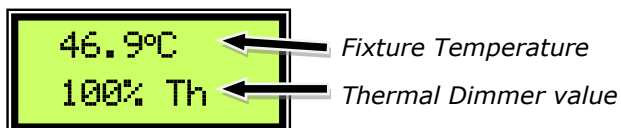

### Thermal Status:

- Fixture Temperature – displays the temperature of the fixture in [°C].
- Thermal Dimmer value – displays the percentage of output current (in reference to the nominal current rating value), which is affected by the thermal protection<sup>9</sup>.

### Channel Statistics:

The Unit constantly measures drop voltage and driving current of every channel.

To view channel statistics, select the desired channel and press [↵] .

The following screen shall be briefly shown for a few seconds:



<sup>8</sup> Only available on supporting fixtures with thermal sensors on-board.

<sup>9</sup> Refer to the Thermal Protection section.

### 3.3 RDM Functionality<sup>10</sup>

The Remote Device Management Protocol (RDM) permits a console or other controlling Device to discover, configure, monitor, and manage intermediate and end-devices connected through a DMX-512 network. RDM provides for intelligent control of devices on a DMX512 network, which has not been previously available outside of proprietary networks.

#### RDM Functions

DR-SD6/12 supports ANSI E1.20 - 2006 RDM, and has besides the required PIDs, the following functions:

- RDM Discovery
- Identification
- DMX Addressing
- DMX Personality (standard 8-bit DMX or DMX with autoaddressing enabled feature)
- Device Label
- Up to 16 Sensors Values
  - PSU Voltage
  - Driver PCB Temperature
  - Every output fixture's temperature(NTC)
  - Every channel's output current

#### **DR-SD6/12 RDM supported parameters list:**

DEVICE\_INFO , IDENTIFY\_DEVICE , DMX\_START\_ADDRESS , SOFTWARE\_VERSION\_LABEL , SUPPORTED\_PARAMETERS ,  
PARAMETER\_DESCRIPTION, [DEVICE\\_LABEL](#) , [DEVICE\\_MODEL\\_DESCRIPTION](#) , [DMX\\_PERSONALITY\\_DESCRIPTION](#) ,  
[DMX\\_PERSONALITY](#) , [SENSOR\\_DEFINITION](#) , [SENSOR\\_VALUE](#) , [MANUFACTURER\\_LABEL](#)

---

<sup>10</sup> RDM support is available at special customer request only.



### 3.4 TP- Fixture Thermal Protection

This feature allows the Unit to receive feedback of the connected fixture's temperature. If the ambient temperature causes the fixture to overheat<sup>11</sup>, the Unit will lower the level of the current passing through the fixture until the fixture's temperature is stabilized within the allowed limitations. If after that the ambient temperature degrades, the Unit will raise the level of the current passing through the fixture. The changes of current will not affect the color of the light; they will only affect the intensity of the light.

It should be noted that the intensity of the light closely depends on the LED's temperature. For example, if the LED driven at 700mA current reaches high temperature, its light output may degrade in half. So if you lower the current through this LED, you will in fact get the same light intensity while the temperature of the LED will be able to stabilize.

In other words, the system adapts itself to the ambient temperature around the fixture.

- ❖ DR-SD has been calibrated using the following NTC sensor:

**Thinking Electronics Industrial - TSM2A103F3802RZ**



If the NTC sensor is not connected, TP protection will be disabled for that Output

The status of Thermal Protection can be viewed in the Output Status<sup>12</sup> menu.

Thermal Dimmer value represents the percentage of the output current rating (in reference to the nominal current rating<sup>13</sup> value).

For example, if the Current Rating is set to 700mA, then the nominal current rating value is 700mA. If the Thermal Dimmer value is at 80% (as a result of operating Thermal Protection), then the maximal output current (at FL) shall be 80% of 700mA, which is:  $700 \cdot 80\% = 560\text{mA}$ .

---

<sup>11</sup> The maximum allowed LED fixture temperature is 75°C

<sup>12</sup> Refer to the Output Status Menu section.

<sup>13</sup> See Current Rating in Admin Maintenance section.

### 3.5 Technical Data

Specification	DR-SD6	DR-SD12
Power Supply	External	
Power Input	24-48VDC	
Current Consumption	Max. 4.5A	Max. 9A
Power Consumption	Max. 180W	Max. 360W
Efficiency	Up to 95%	
Heat Dissipation	< 20 Watt	
Maximum Driving Current	Adjustable (50-700mA per channel)	
Output Current Tolerance	<5%	
Load Regulation	1%	
Output Voltage	Max. 48VDC	
Output Channels	6 channels	12 channels
Fixture Output	2 outputs 1-12 LEDs per channel, up to 72 LEDs total	4 outputs 1-12 LEDs per channel, up to 144 LEDs total
Environment	IP-40, dry location	
Working Temperature	-10 to + 40°C	
Storage Temperature	-20 to + 70°C	
Working Humidity	20-90% RH, non condensing	
Storage Humidity	10-90% RH, non condensing	
Communication Protocol Support	DMX-512, Auto-addressing, RDM (upon request)	
DMX Working Mode	1-6 channels	1-12 channels
Color Grades	256 level (each color) total 16,770,000 colors	
Fixture Protection	Open line, short line and wrong interconnection protection	
Output Protection	PTC - Auto recovery after fault condition is removed	
Thermal Protection (Unit)	Reduces output current to eliminate Unit overheating	
Thermal Protection (Fixture)	Reduces light output to eliminate fixture overheating	
DMX Connection Type	RJ-45	
Power IN Connection Type	Screw terminal block, 4 pin, pitch 5mm	
Output Connection Type	Pluggable terminal block, 8 pin, pitch 3.5mm	
UL / cTUVus Approvals	UL 60950-1:2007, CAN/CSA-C22.2 No.60950-1-07	
CE EMC Approvals	EN 55022, EN 55024, EN 61000-3-2, EN 61000-3-3, IEC 61000-4-2, IEC 61000-4-3, IEC 61000-4-4, IEC 61000-4-5, IEC 61000-4-6, IEC 61000-4-11	
CE FCC Approvals	FCC Part 15, Subpart B, Class A Radiated Emission Only	

### Typical Characteristics

( $T_A=25^{\circ}\text{C}$  unless stated otherwise, Driving current 700mA)

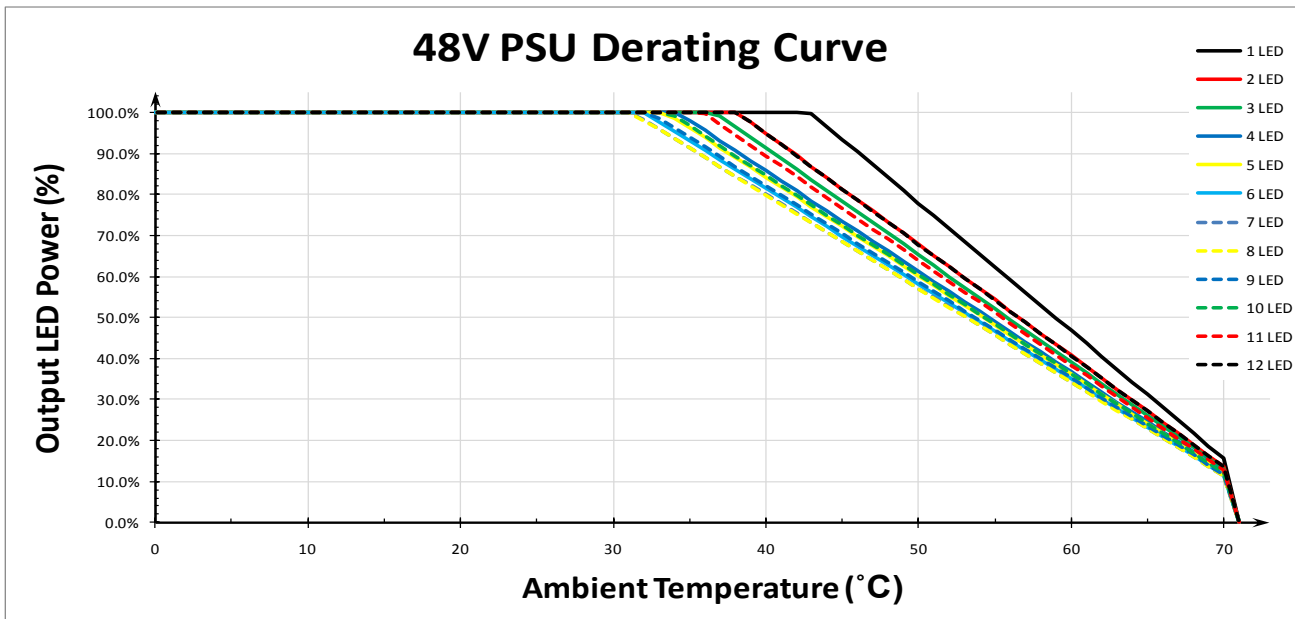
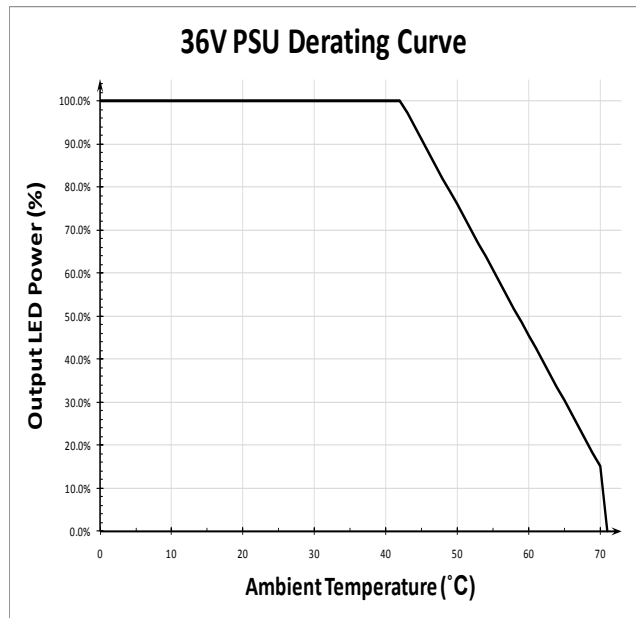
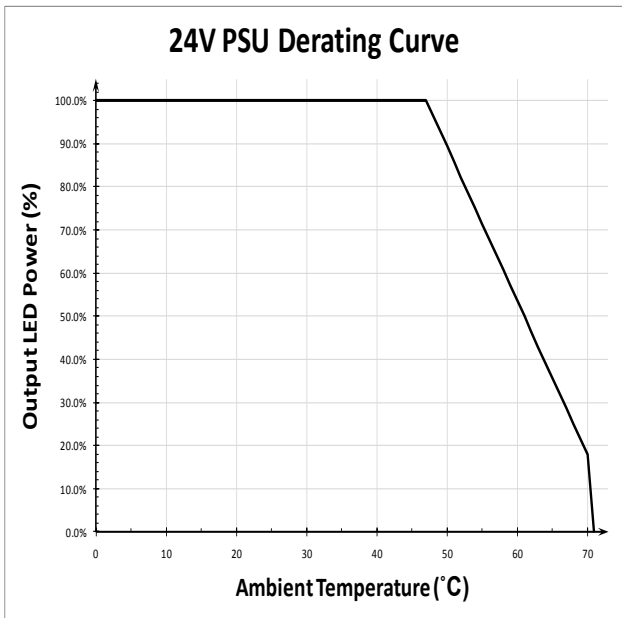
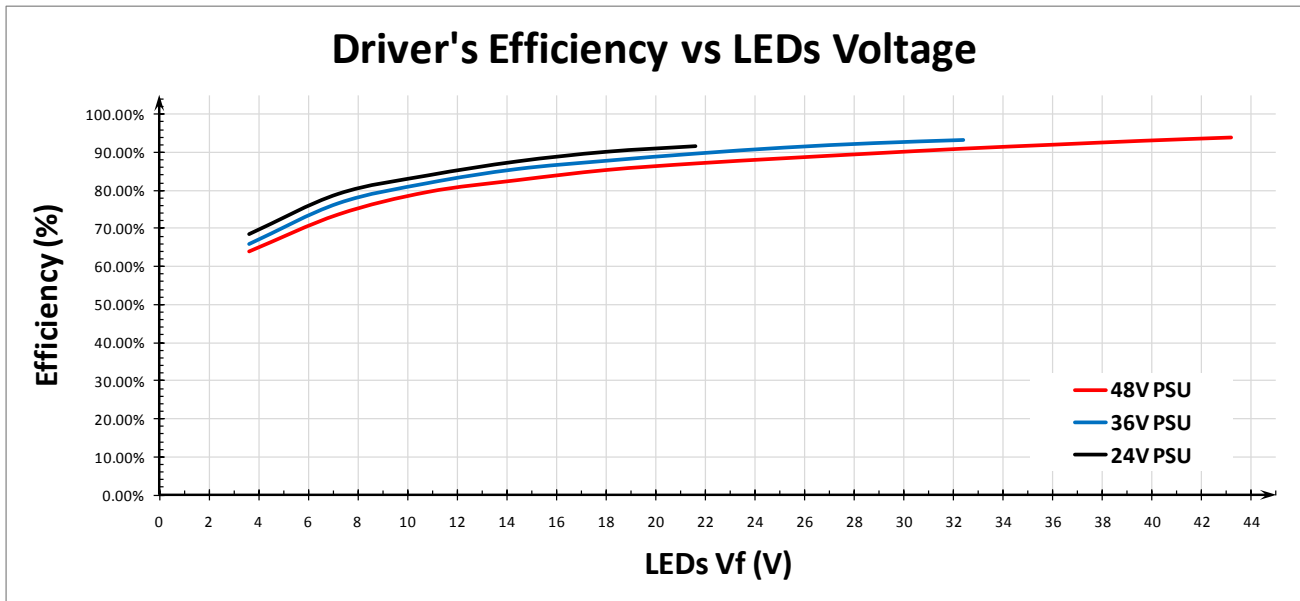

## Chapter 4: Problem Solving

### 4.1 Troubleshooting

The following table provides corrective actions for possible trouble situations. If further assistance is required, please contact a D-LED customer service representative.

#### DR-SD 6/12 Troubleshooting table:

TROUBLE		POSSIBLE CAUSE(S)	CORRECTIVE ACTION
Device does not function.		DR-SD 6/12 is not receiving power from the external DC Power Supply	Verify POWER IN connections. Ensure PSU's AC circuit breaker is not tripped.
Device not responding to DMX-512 input signal		DR-SD 6/12 is not in DMX-512 Run Mode	Set DR-SD 6/12 to DMX-512 Run Mode.
		Bad DMX-512 wiring or DMX-512 signal is missing	Check DMX-512 wiring. When Unit is receiving correct DMX-512 signal there will be  icon blinking on the top right of the LCD display.
<b>Output x FAULT!!!</b> is showed on the LCD display		Possible wiring problem with the <b>x</b> Output.	Enter Output Status menu, select the <b>x</b> Output and review the status messages.
Error messages (in the Output Status menu)	CHX: Short Circuit!!!	Short circuit on channel X.	Check the output wiring.
	CHX: Wiring Fault!!!	Incorrect connection wiring on channel X.	Check the output wiring.
	Hardware Fault!!!	Internal circuitry malfunction.	Contact a D-LED customer service representative.

## Chapter 5: Firmware Update

### 5.1 Updating the Firmware version

The firmware version of the Unit can be updated from another Unit. This feature is available on Units with firmware v1.5 or higher.

1. Connect the **DMX IN** of the Master Unit to the **DMX IN** of the Slave Unit. Use a standard pin-to-pin CAT5 cable (refer to the DMX512 Data wiring section):

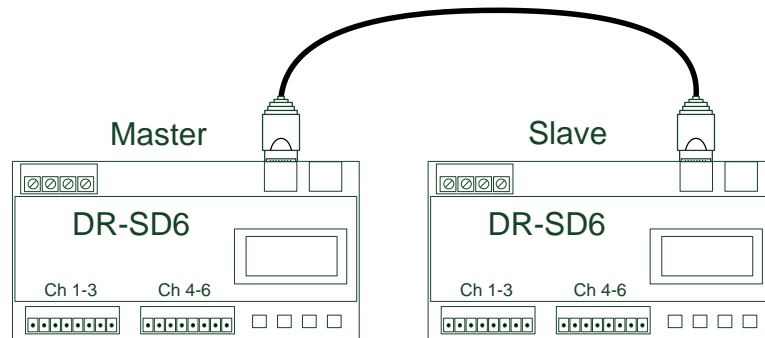

2. Power up the Master Unit.
3. **On the Master Unit:** select the Send Firmware option in the Admin Maintenance menu (see above). You should see the following message on the LCD screen:

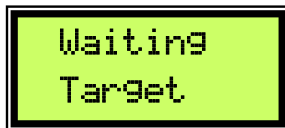

4. Power up the Slave Unit.
5. **On the Slave Unit:** select the Update Firmware option in the Admin Maintenance menu (see above).

Alternatively, simultaneously press and hold buttons **[↵]** and **[ESC]**, power up the Unit and release the **[↵]** and **[ESC]** buttons.

6. Wait for the firmware update process completion. The Slave Unit shall automatically reboot.



Do not disconnect the DMX cable and do not power down the Units during firmware update!

7. To exit the Update Mode on the Master Unit press and hold **[ESC]** for 5 seconds.

## 5.2 Firmware Update Q&A

1. **Question:** I disconnected the DMX cable during the update by mistake!

Now the Master Unit displays:



And the Slave Unit is stuck at the following screen:



What should I do?

**Answer:** Follow these simple steps:

- a) On the Master Unit press the [↵] button. Verify that the following message is displayed:



- b) Reconnect the **DMX IN** of the Master Unit to the **DMX IN** of the Slave Unit.  
c) Power up the Slave Unit.  
d) Wait for the firmware update process completion. The Slave Unit shall automatically reboot.

2. **Question:** Something happened during Firmware Update!

Now the Slave Unit displays:

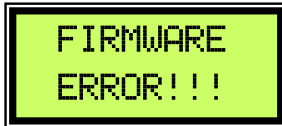

What should I do?

**Answer:** This can happen due to various reasons, such as power loss/reset on Master or Slave Unit or faulty/damaged DMX cable. Do the following:

- a) Verify that the DMX cable is intact and the wiring is correct (refer to DMX512 Data wiring section).  
b) Set the Master Unit to Send Firmware in the Admin Maintenance Menu. Verify that the following message is displayed:



- c) Reconnect the **DMX IN** of the Master Unit to the **DMX IN** of the Slave Unit.  
d) Power up the Slave Unit.  
e) Wait for the firmware update process completion. The Slave Unit shall automatically reboot.